

# Data Sheet



Article number: 021816011218

Description: Clamp with bracket and rubber  
SPGU 6011. 218/30 SK

## Measures

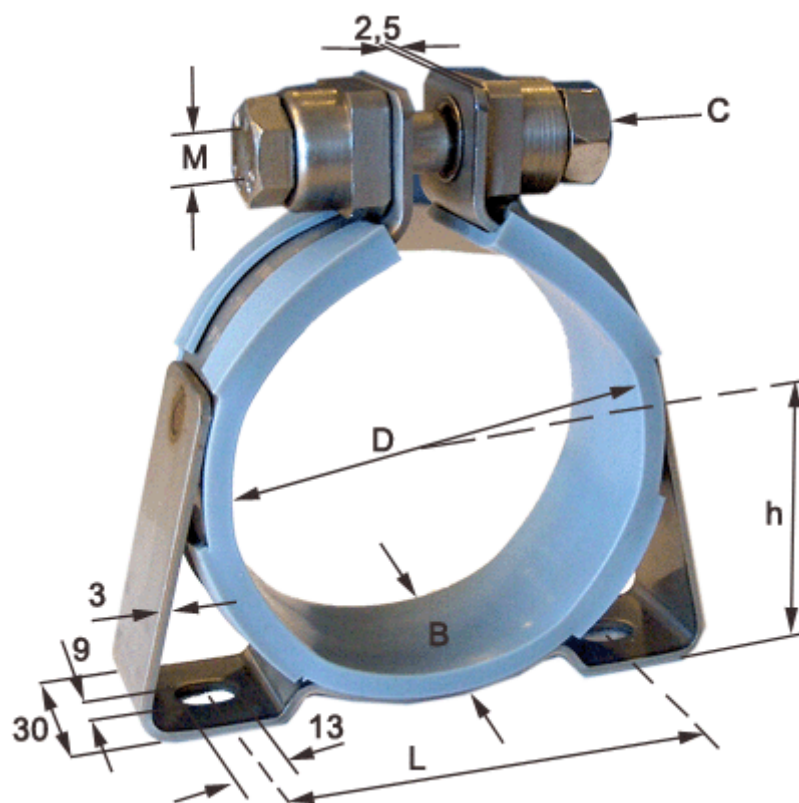

C (screw type) = SK hexagon screw

Diameter D = 218

h = 118

L = 216

Width B = 30